



- LEGENDA**
- ⊕ Peillocatie
 - 25 Huisnummer
 - 1234 Perceelsnummer
 - Onderzoeklocatie
 - Bebauwing (buitenmuur)
 - Perceelsgrens (Kadaster)
 - /// Niet mogelijk te peilen
 - A Raai-code
 - Dwarsraai

Locatie: Haven Zuid Spijkenisse			
Type: Waterbodemonderzoek			
Omschrijving: Ligging dwarsraaien			
Projectnr: 0950301C		Bestandsnaam: 0950301C	
Formaat: A3	Getekend: MJG	Datum: 23-04-2010	Tekeningnr.: 1
Schaal: 1 : 2000			
0m 20m 100m			

PJ Milieu BV

Adres: Nijverheidsstraat 21
3861 RJ Nijkerk
Telefoon: 033 - 245 85 11
E-mail: info@pjmilieu.nl
Internet: www.pjmilieu.nl

Aan de maten kunnen geen rechten worden ontleend.

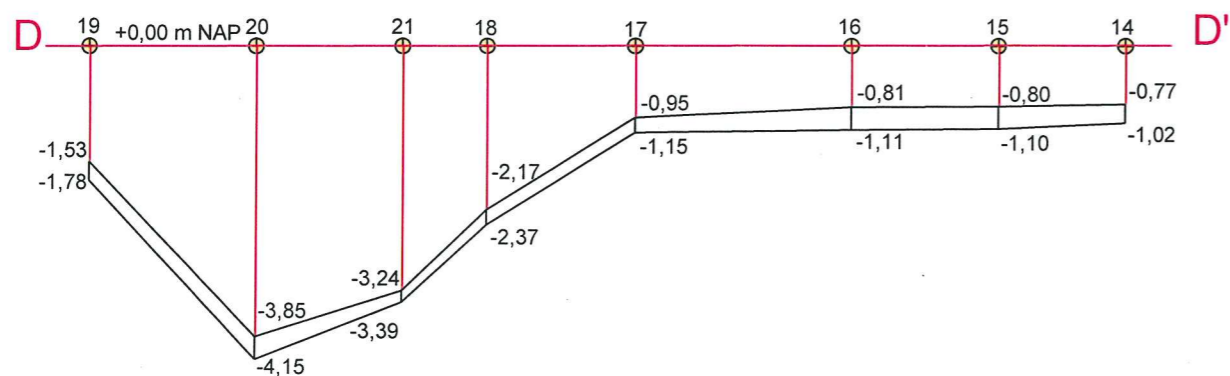
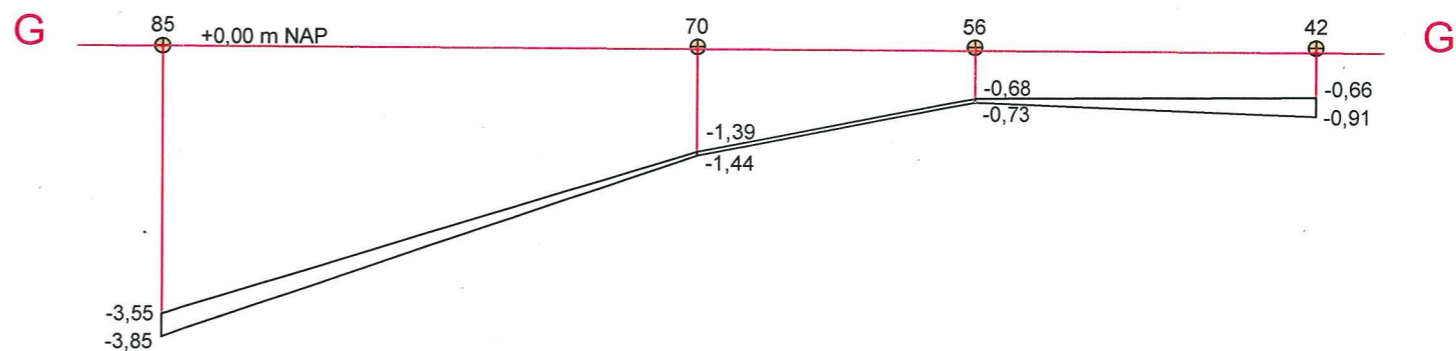
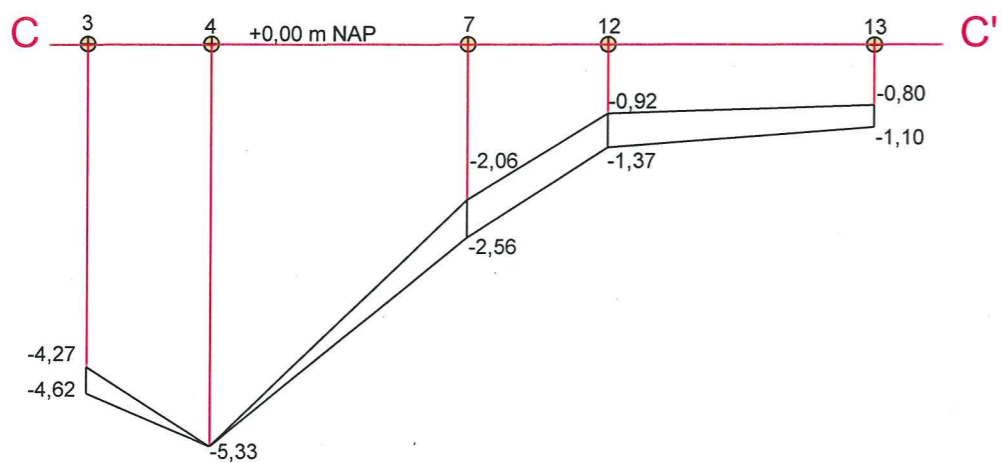
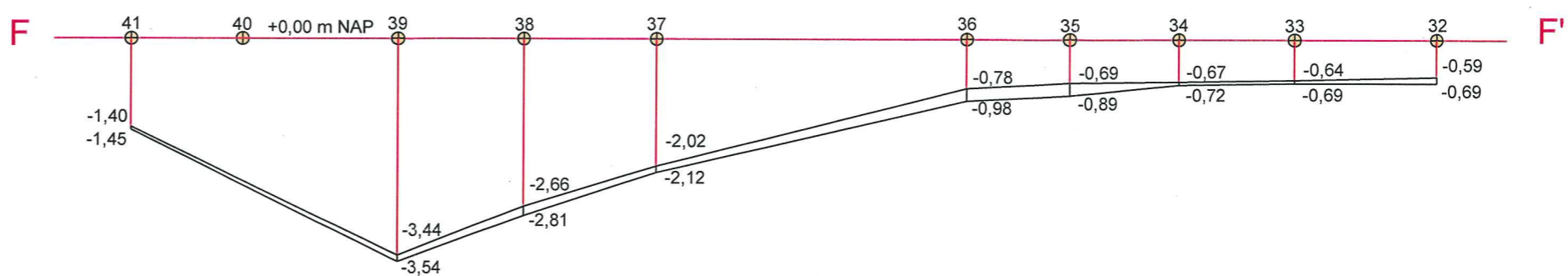
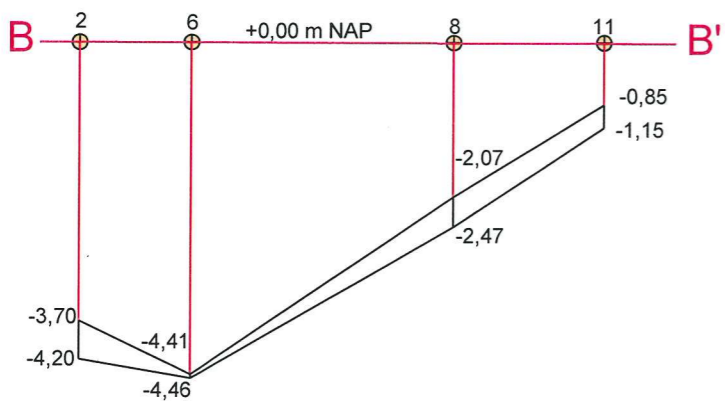
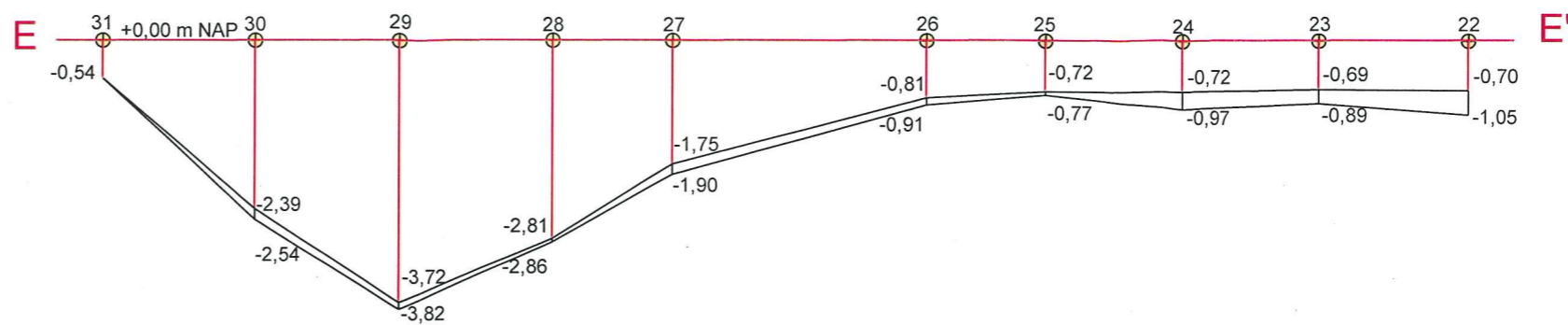
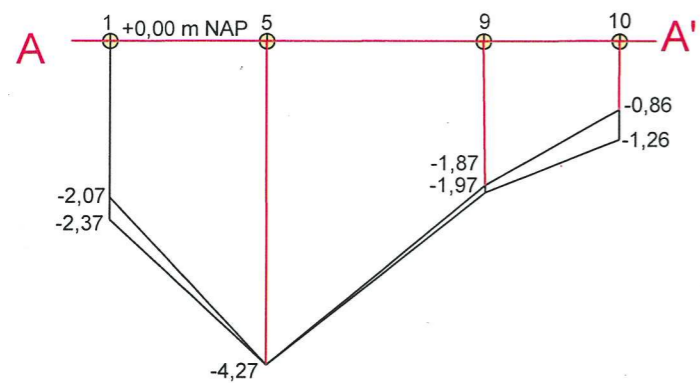

Locatie:			
Haven Zuid Spijkenisse			
Type:			
Verkenndend waterbodemonderzoek			
Omschrijving:			
Dwarsprofielen A t/m G			
Projectnr:		Bestandsnaam:	
0950301C		0950301C_2	
Formaat:	Getekend:	Datum:	Tekeningnr:
A3	MJG	01-05-2010	2
Schaal horizontaal:	0m	5m	25m
1 : 500			
Schaal verticaal:	0m	1m	5m
1 : 100			

PJ Milieu BV

Adres: Nijverheidsstraat 21
3861 RJ Nijkerk
Telefoon: 033 - 245 85 11
E-mail: info@pjmilieu.nl
Internet: www.pjmilieu.nl



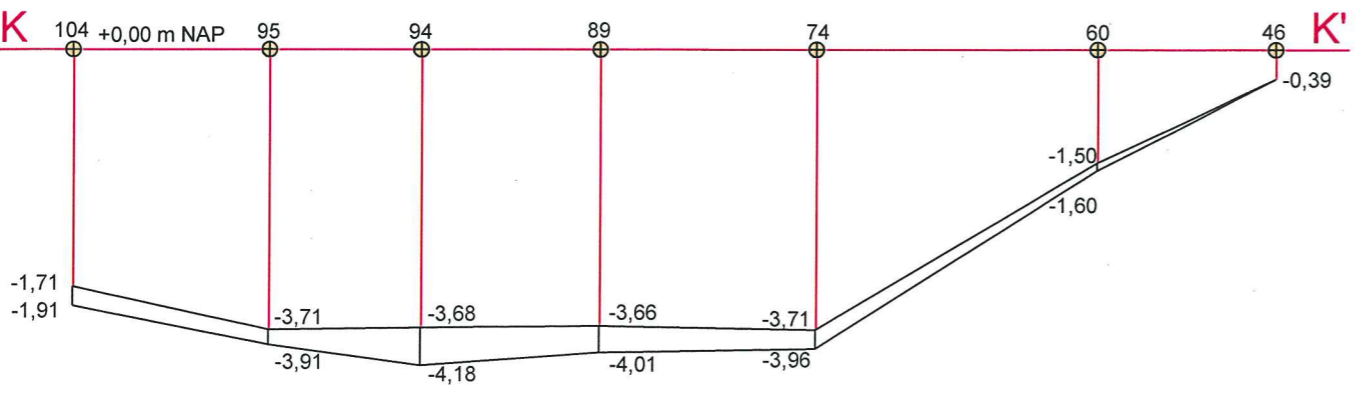
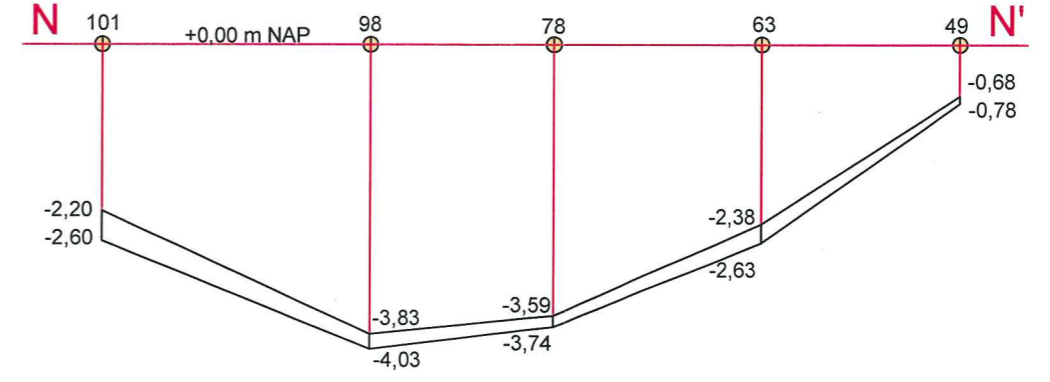
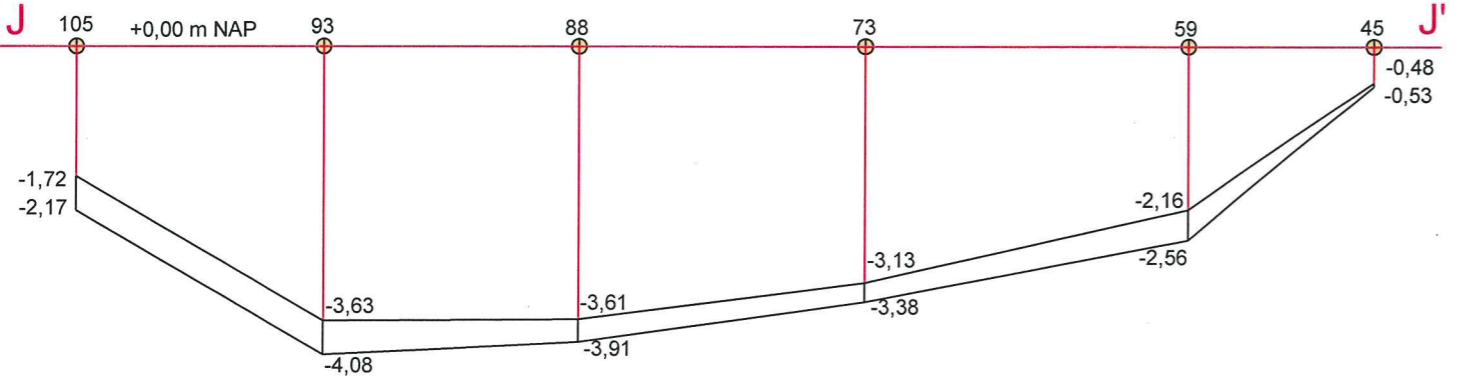
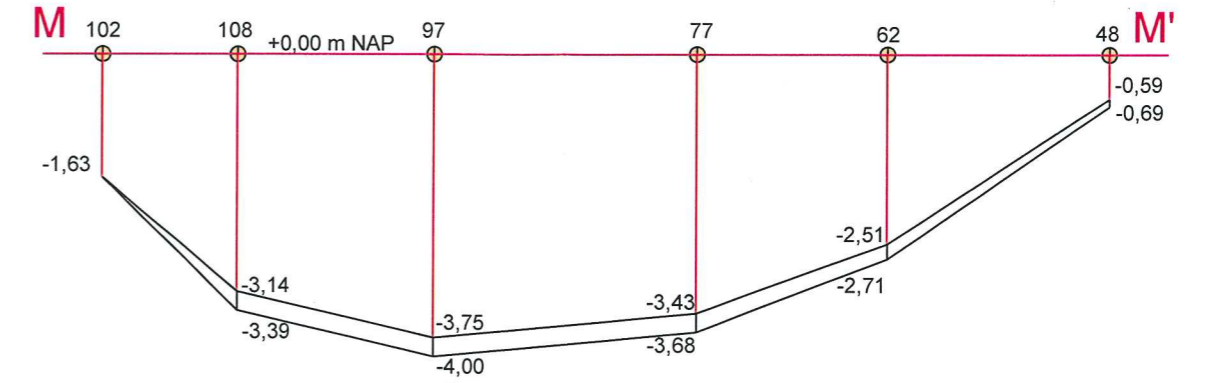
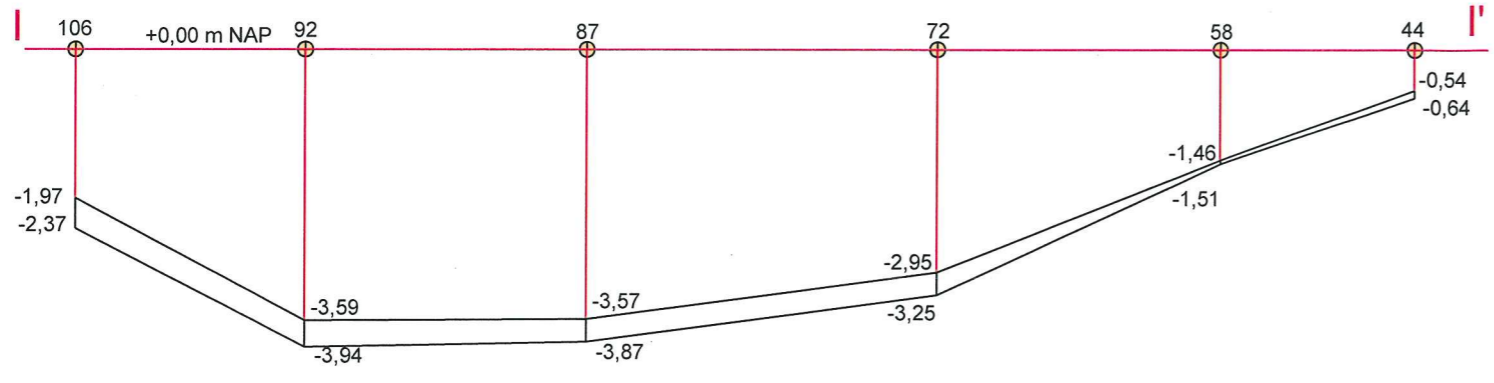
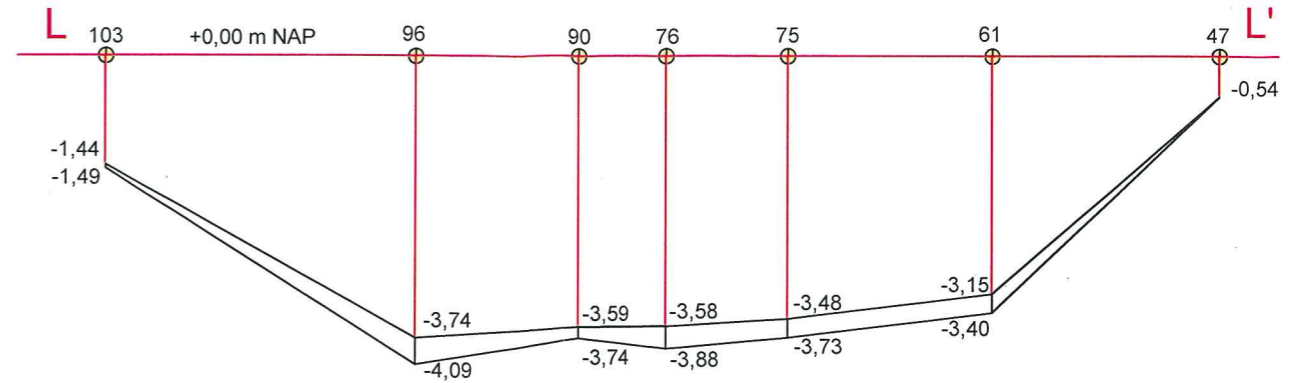
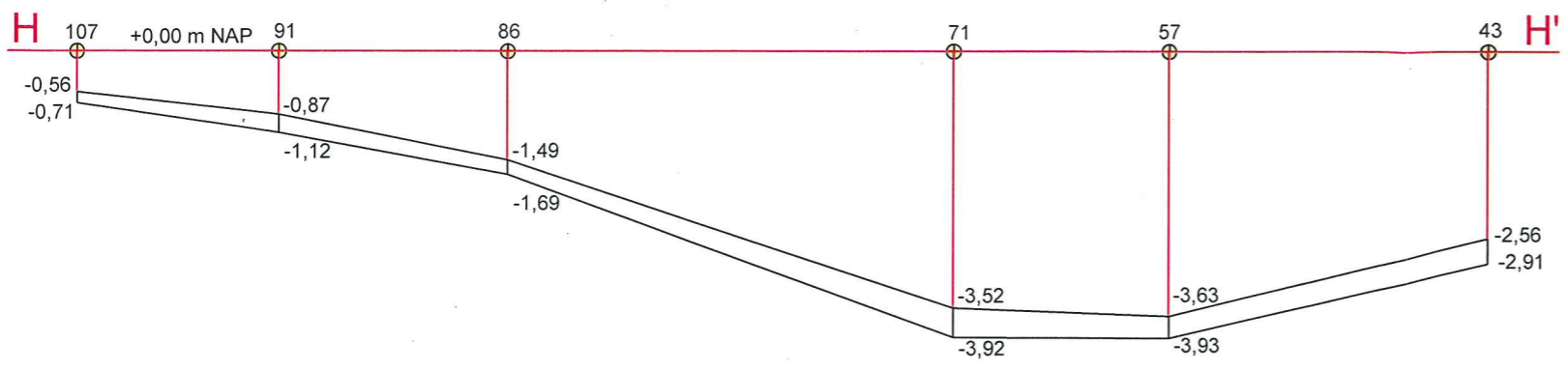

Locatie: Haven Zuid Spijkenisse			
Type: Verkennd waterbodemonderzoek			
Omschrijving: Dwarsprofielen H t/m N			
Projectnr: 0950301C	Bestandsnaam: 0950301C_2		
Formaat: A3	Getekend: MJG	Datum: 01-05-2010	Tekeningnr: 3
Schaal horizontaal: 1 : 500	0m 5m 25m		
Schaal verticaal: 1 : 100	0m 1m 5m		

PJ Milieu BV
 Adres: Nijverheidsstraat 21
 3861 RJ Nijkerk
 Telefoon: 033 - 245 85 11
 E-mail: info@pjmilieu.nl
 Internet: www.pjmilieu.nl



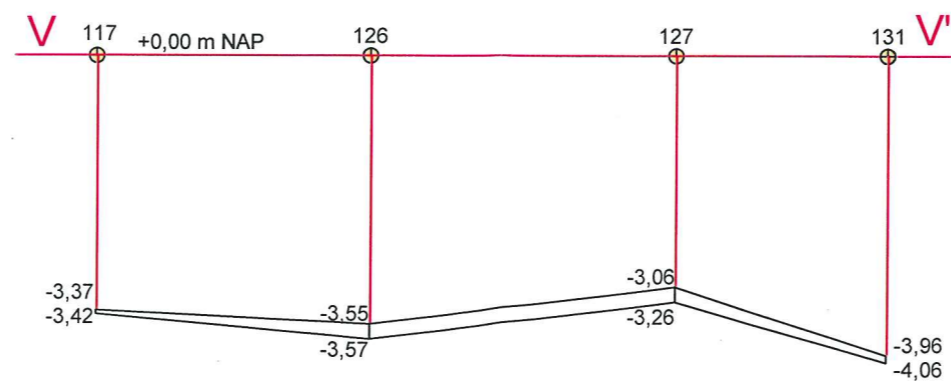
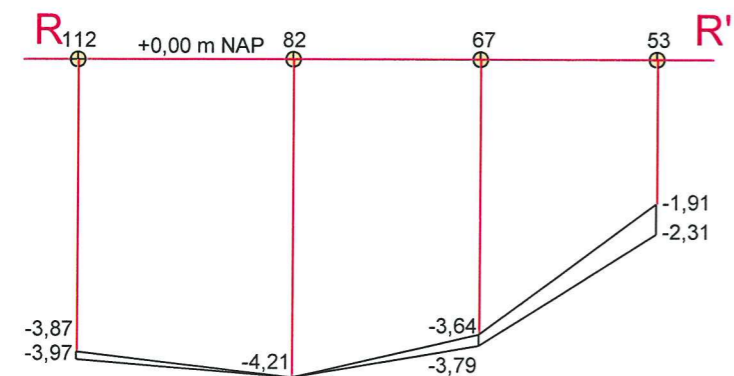
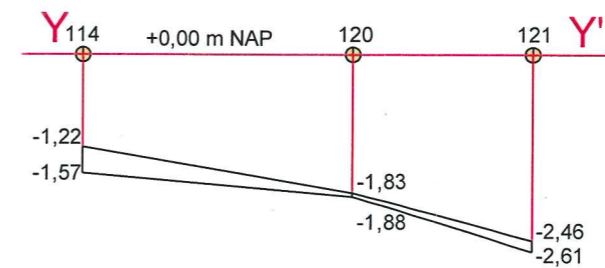
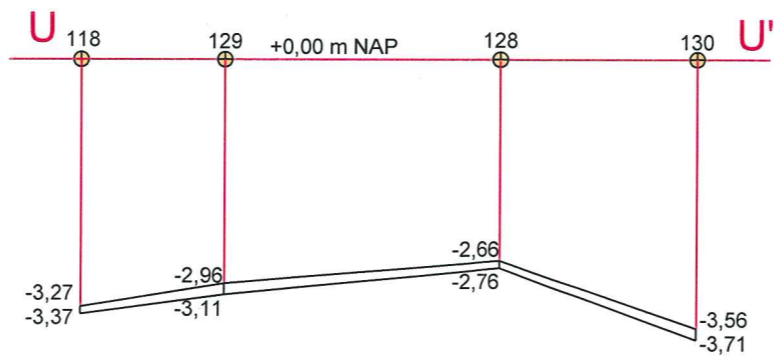
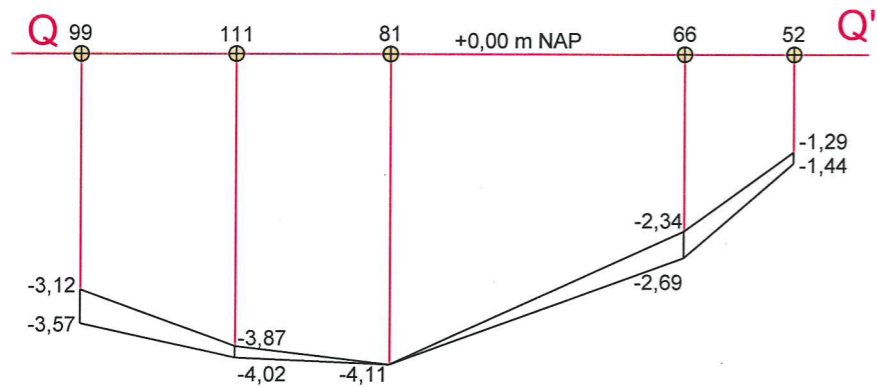
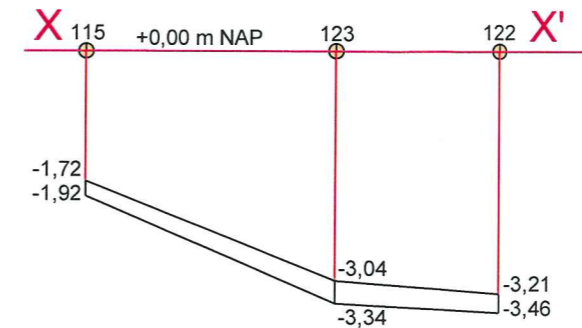
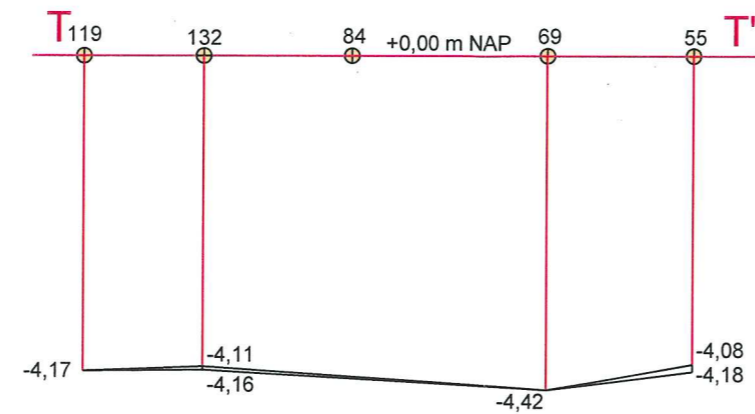
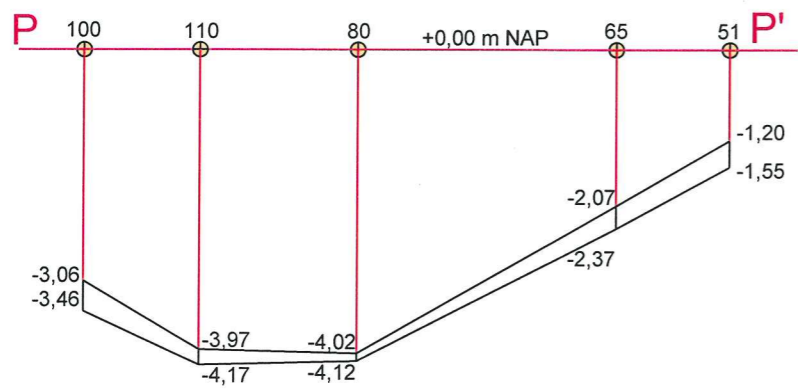
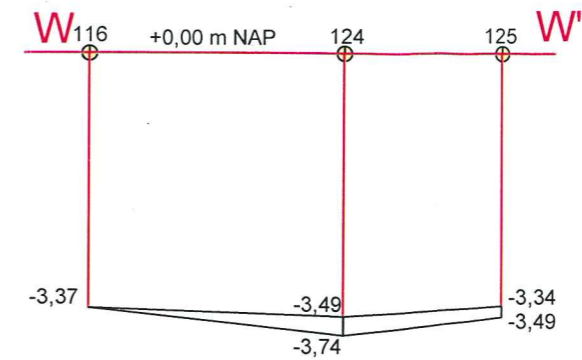
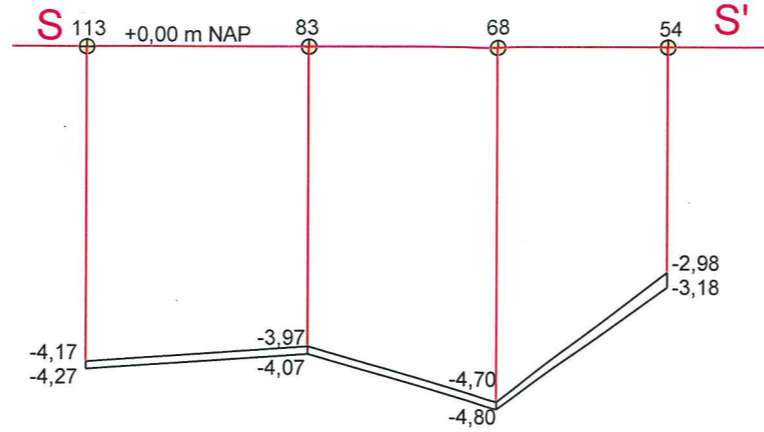
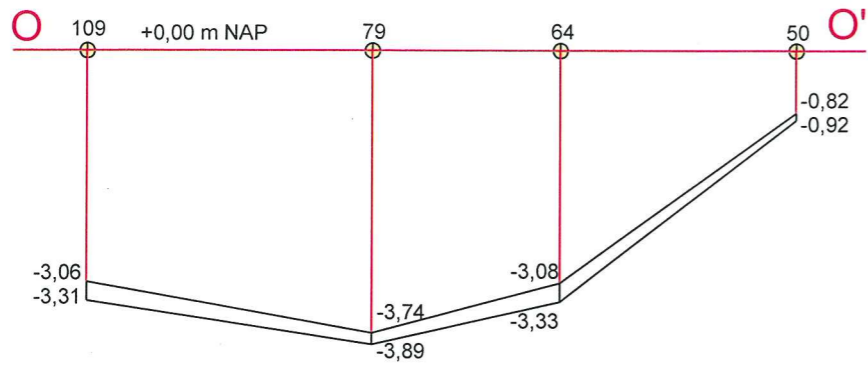

Locatie: Haven Zuid Spijkenisse			
Type: Verkenndend waterbodemonderzoek			
Omschrijving: Dwarsprofielen O t/m Y			
Projectnr: 0950301C		Bestandsnaam: 0950301C_2	
Formaat: A3	Getekend: MJG	Datum: 01-05-2010	Tekeningnr: 4
Schaal horizontaal: 1 : 500	0m 5m 25m		
Schaal verticaal: 1 : 100	0m 1m 5m		

PJ Milieu BV

Adres: Nijverheidsstraat 21
3861 RJ Nijkerk
Telefoon: 033 - 245 85 11
E-mail: info@pjmilieu.nl
Internet: www.pjmilieu.nl





- LEGENDA**
- ⊗ Monsternamepunt
 - 25 Huisnummer
 - 1234 Perceelsnummer
 - - - - - Onderzoekslocatie
 - ▭ Bebauwing (buitenmuur)
 - Perceelsgrens (Kadaster)
 - ▨ Water

Locatie: Haven Zuid Spijkenisse			
Type: Waterbodemonderzoek			
Omschrijving: Situering monsternamepunten			
Projectnr: 0950301C		Bestandsnaam: 0950301C_3	
Formaat: A3	Getekend: MJG	Datum: 01-05-2010	Tekeningnr: 5
Schaal: 1 : 2000			
0m 20m 100m			

PJ Milieu BV

Adres: Nijverheidsstraat 21
3861 RJ Nijkerk
Telefoon: 033 - 245 85 11
E-mail: info@pjmilieu.nl
Internet: www.pjmilieu.nl



Aan de maten kunnen geen rechten worden ontleend.